



**SAHUNG<sup>®</sup>**  
Industrial Lighting

# INDUSTRIAL LIGHTING

SAHUNG LIGHTING PRODUCT MANUAL

---

 Hangzhou, China

**LED** BAF9011 Ex-proof Light



**Product Features**

1. Aluminum alloy die-casting shell, high voltage electrostatic painting surface, high temperature resistance, aging resistance;
2. Suitable for explosive gas environment zone 1 and zone 2;
3. LUMILEDS led chip with high light efficiency;
4. Tempered glass cover, high temperature resistance, high strength;
5. The outlet line uses G3/4 inch pipe thread outlet for wiring and installation;
6. Sahung driver power supply, waterproof and moisture-proof, stable performance;
7. IP65, waterproof and dust-proof, in all kinds of harsh environment it can also maintain normal work.

**Beam Angle**

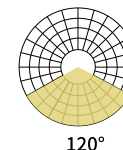

**Parameters**



Brand	<b>SAHUNG</b>
Model	BAF9011
Material	Ex Proof AL Alloy
Voltage	AC85-265V
Condition Temp	-40~85°
Anticorrosion	WF2
Ex-Proof Rate	Exd IIC T6
Warranty	3~5 years
Power	20W~200W
Cable inlet	G3/4
Driver	<b>SAHUNG</b> (Optional)
Anti-Surge	4~6KV
Power Factor	0.97PF
IP rating	IP65
Efficiency	90%
Chip	LUMILEDS (Optional)
Lumens	140 lm/W
CRI	80Ra
CCT	2700K~6500K

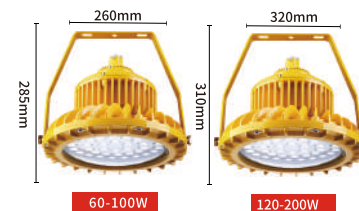

**Safety Certification**



BAF9012 Ex-proof Light **LED**

**Product Features**

1. Aluminum alloy die-casting shell, high voltage electrostatic painting surface, high temperature resistance, aging resistance;
2. Made in accordance with IIC explosion-proof standards, for IIA, IIB explosion gas environment
3. LUMILEDS led chip with high light efficiency;
4. Tempered glass cover, high temperature resistance, high strength;
5. Sahung driver power supply, waterproof and moisture-proof, stable performance;
6. IP65 waterproof and dust-proof, in all kinds of harsh environment it can also maintain normal work.

**Beam Angle**

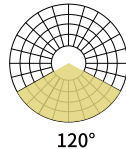
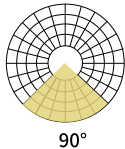

**Parameters**

Brand	<b>SAHUNG</b>
Model	BAF9012
Material	Die-cast Aluminium
Voltage	AC100-265V
Condition Temp	-45~80°
Anticorrosion	WF2
Ex-Proof Rate	Exd IIC T6
Warranty	3~5 years
Power	30W~200W
Cable inlet	G3/4
Driver	<b>SAHUNG (Optional)</b>
Anti-Surge	4~6KV
Power Factor	0.95PF
IP rating	IP65
Efficiency	90%
Chip	<b>LUMILEDS (Optional)</b>
Lumens	140lm/W
CRI	80Ra
CCT	2700K~6500K

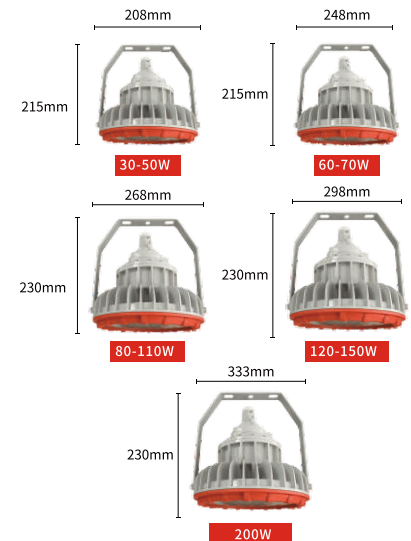

**Safety Certification**



**LED** BAF9018-C Ex-proof Light



**Product Features**

1. Aluminum alloy die-casting shell, high temperature resistance;
2. Made in accordance with IIC explosion-proof standards, for IIA, IIB explosion gas environment ;
3. The lamp is well sealed and isolated from external sparks, gas, water and dust;
4. OSRAM led chip with high light efficiency;
5. The outlet line uses G3/4 inch pipe thread outlet for wiring and installation;
6. IP65 ,waterproof and dust-proof, in all kinds of harsh environment it can also maintain normal work.

**Beam Angle**

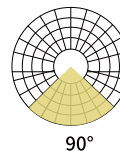

**Parameters**

Brand	<b>SAHUNG</b>
Model	BAF9018-C
Material	Ex-proof Die-Cast Al
Voltage	AC85-265V
Condition Temp	-20~50°
Anticorrosion	WF2
Ex-Proof Rate	Exd IIC T4
Warranty	3~5 years
Power	100W~200W
Cable inlet	G3/4

Driver	<b>SAHUNG</b> (Optional)
Anti-Surge	4~6KV
Power Factor	0.95PF
IP rating	IP65
Efficiency	90%

Chip	OSRAM (Optional)
Lumens	140lm/W
CRI	80Ra
CCT	2700K~6500K

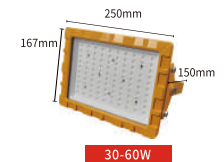

**Safety Certification**

## Product Features

1. Aluminum alloy die-casting shell, high temperature resistance;
2. Made in accordance with IIC explosion-proof standards, for IIA, IIB explosion gas environment
3. LUMILEDS high light efficiency LED chip;
4. Tempered glass cover, high temperature resistance, high strength;
5. The outlet line uses G3/4 inch pipe thread outlet for wiring and installation;
6. Sahung driver power supply, waterproof, input voltage AC85~265V;
7. IP65, waterproof and dust-proof, in all kinds of harsh environment it can also maintain normal work.

## Beam Angle

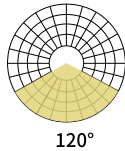

BAF180 Ex-proof Light

LED

## Parameters



<b>Brand</b>	<b>SAHUNG</b>
<b>Model</b>	BAF180
<b>Material</b>	Die-Cast Al+Tempered Glass
<b>Voltage</b>	AC100-277V
<b>Condition Temp</b>	-30~85°
<b>Anticorrosion</b>	WF2
<b>Ex-Proof Rate</b>	Exd IIC T6
<b>Warranty</b>	3~5 years
<b>Power</b>	10W~60W
<b>Cable Inlet</b>	G3/4

<b>Driver</b>	<b>SAHUNG (Optional)</b>
<b>Anti-Surge</b>	4~6 KV
<b>Power Factor</b>	0.95PF
<b>IP Rating</b>	IP65
<b>Efficiency</b>	90%

<b>Chip</b>	<b>LUMILEDS (Optional)</b>
<b>Lumens</b>	140lm/W
<b>CRI</b>	80Ra
<b>CCT</b>	2700K~6500K

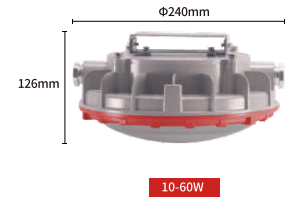

## Safety Certification

CE FC TUV LVD SAA EMC

**LED** BAF9189 Tri-proof Lights



**Product Features**

1. Aluminum alloy die-casting shell, high temperature resistance;
2. Anti-glare milky PC lens, avoid dazzling;
3. High light efficiency chips: OSRAM, CREE;
4. The outlet line uses G3/4 inch pipe thread outlet for wiring and installation;
5. 304 stainless steel screw, good tension, corrosion proof;
6. Sahung driver power supply, waterproof, input voltage AC85~265V, applicable to global voltage;
7. IP65 protection level, waterproof and dust-proof, in all kinds of harsh environment it can also maintain normal work.

**Beam Angle**

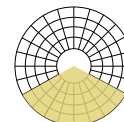

120°



**Parameters**

<b>Brand</b>	<b>SAHUNG</b>
<b>Model</b>	BAF9189
<b>Material</b>	Die-cast Aluminium
<b>Voltage</b>	AC85-265V
<b>Condition temp</b>	-20~50°
<b>Warranty</b>	3-5 years
<b>Power</b>	30W~100W
<hr/>	
<b>Driver</b>	<b>SAHUNG (Optional)</b>
<b>Anticorrosion</b>	WF2
<b>Power Factor</b>	0.95PF
<b>IP rating</b>	IP65
<b>Cable inlet</b>	G3/4
<hr/>	
<b>Chip</b>	<b>OSRAM (Optional)</b>
<b>Lumens</b>	140lm/w
<b>CRI</b>	80Ra
<b>CCT</b>	2700K~6500K



228mm

228mm

30-60W



305mm

310mm

70-100W

**Safety Certification**

CE FC TUV LVD SAA EMC

BAF97R81 Ex-proof Light **LED**

**Product Features**

1. Explosion-proof die-cast aluminum shell, explosion-proof;
2. LUMILEDS led chip with high light efficiency;
3. Made in accordance with IIC explosion-proof standards, for IIA, IIB explosion gas environment;
4. The lamp is well sealed and isolated from external sparks, gas, water and dust;
5. The default power supply is MOSO;
6. The bracket and the PC lampshade can be configured;
7. IP65 protection level, waterproof and dust-proof, in all kinds of harsh environment it can also maintain normal work.

**Beam Angle**

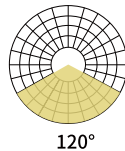

**Parameters**

<b>Brand</b>	<b>SAHUNG</b>
<b>Model</b>	BAF97R81
<b>Material</b>	Die-cast Al+Wire Mesh
<b>Voltage</b>	AC100-240V
<b>Condition temp</b>	-30~85°
<b>Anticorrosion</b>	WF2
<b>Ex-Proof Rate</b>	Exd IIC T6Gb
<b>Warranty</b>	3~5 years
<b>Power</b>	40W~120W
<b>Cable inlet</b>	G3/4
<b>Driver</b>	MOSO (Optional)
<b>Anti-Surge</b>	4KV~6KV
<b>Power Factor</b>	0.95PF
<b>IP rating</b>	IP65
<b>Efficiency</b>	90%
<b>Chip</b>	LUMILEDS (Optional)
<b>Lumens</b>	140lm/w
<b>CRI</b>	80Ra
<b>CCT</b>	2700K~6500K



**Safety Certification**

Ex CE FC TUV LVD SAA EMC

LED

BAF-T8 Ex-proof Light



Product Features

1. Aluminum alloy die-casting shell, good heat dissipation ;
2. Iron mesh cover, protect the lamp body ;
3. Transparent glass lampshade, explosion-proof and moisture-proof;
4. High quality LED tube, soft light, durable;
5. Suitable for petroleum, petrochemical, chemical enterprises and other dangerous places;
6. IP65 protection level, waterproof and dust-proof, in all kinds of harsh environment it can also maintain normal work.

Beam Angle



Parameters



Brand	SAHUNG
Model	BAF-T8
Material	Die-cast Al+Tempered Glass
Voltage	AC220V
Condition temp	-20~50°
Anticorrosion	WF2
Ex-Proof Rate	Exd IIB T6
Warranty	3~5 years
Power	LED1*18W~LED3*18W
Cable inlet	G1/2

Driver	SAHUNG(Optional)
Anti-Surge	4KV~6KV
Power Factor	0.97PF
IP rating	IP65
Efficiency	93%

Chip	LEDT8
Lumens	100lm/w
CRI	80Ra
CCT	2700K~6500K

SAHUNG

Model	BAF-T8
Material	Die-cast Al+Tempered Glass
Voltage	AC220V
Condition temp	-20~50°
Anticorrosion	WF2
Ex-Proof Rate	Exd IIB T6
Warranty	3~5 years
Power	LED1*18W~LED3*18W
Cable inlet	G1/2

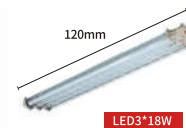
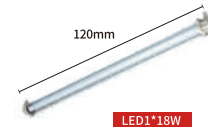

Safety Certification



BAF188 Ex-proof Street Light LED

Product Features

1. Aluminum alloy die-casting shell, high temperature resistance;
2. The light source cavity and the power supply cavity are separated;
3. Toughened glass cover, light transmittance is up to 96%, true reduction of light color;
4. Fast heat dissipation;
5. LUMILEDS led chip with high light efficiency;
6. Suitable for IIA, IIB, IIC explosive gas environment;
7. IP65 protection level, waterproof and dust-proof, in all kinds of harsh environment it can also maintain normal work.

Beam Angle

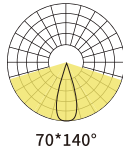

Parameters

Brand	<b>SAHUNG</b>
Model	BAF188
Material	Ex-proof Die-Cast Al
Voltage	AC100-270V
Condition temp	-30~85°
Anticorrosion	WF2
Ex-Proof Rate	Exd IIC T6Gb
Warranty	3~5 years
Power	40W~180W
Caliber	60mm

Driver	<b>SAHUNG(Optional)</b>
Anti-Surge	4KV~6KV
Power Factor	0.95PF
IP rating	IP65
Efficiency	90%

Chip	<b>LUMILEDS(Optional)</b>
Lumens	140lm/w
CRI	80Ra
CCT	2700K~6500K



Safety Certification



# LED BAF8050 Ex-proof Light



## Product Features

1. Explosion-proof die-cast aluminum shell, explosion-proof and anti-aging;
2. Toughened glass cover, true reduction of light color;
3. The outlet line uses G3/4 inch pipe thread outlet;
4. 304 stainless steel screw, good tensile and corrosion resistance;
5. LUMILEDS chip with high light efficiency;
6. IP65 protection level, waterproof and dust-proof, in all kinds of harsh environment it can also maintain normal work.

## Beam Angle

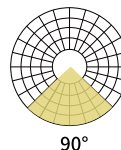

## Parameters

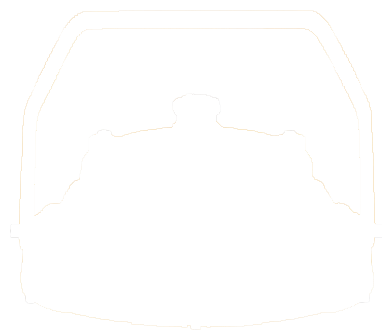

Brand	<b>SAHUNG</b>
Model	BAF8050
Material	Die-cast Aluminium
Voltage	AC100-265V
Anticorrosion	WF2
Ex-Proof Rate	Exd IIC T6
Condition temp	-20~50°
Warranty	3~5 years
Power	30W~150W
Cable inlet	G3/4

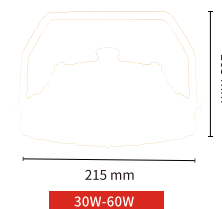

Driver	<b>SAHUNG(Optional)</b>
Power Factor	0.95PF
IP rating	IP65
Cable inlet	G3/4

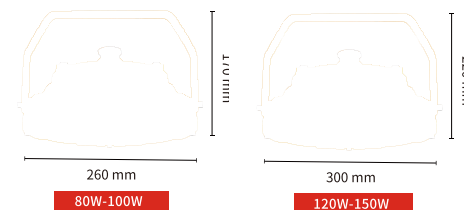

Chip	LUMILEDS (Optional)
Lumens	140lm/w
CRI	80Ra
CCT	2700K~6500K

## Safety Certification

CE FC TUV LVD SAA EMC

LED

## GBM High Bay Light



### Product Features

1. The lamp is made from graphene material, high thermal conductivity, strong hardness;
2. Die cast structure design, good heat dissipation;
3. Optical PC lens, high light transmittance, optimize lighting performance;
4. Standard color development index, truly restore the environment color;
5. 304 Metal rings, good rust prevention, rm installation
6. IP65 ,waterproof and dust-proof, in all kinds of harsh environment it can also maintain normal work.

### Beam Angle



### Parameters

Brand	<b>SAHUNG</b>
Model	GBM
Material	Graphene
Voltage	AC100-277V
Condition Temp	-20~50°
Warranty	3~5years
Power	100W~200W

Driver	<b>SAHUNG</b> (Optional)
Anti-Surge	4KV~6KV
Power Factor	0.95PF
IP rating	IP65
Efficiency	90%

Chip	<b>CREE</b> (Optional)
Lumens	150lm/W
CRI	80Ra
CCT	2700K~6500K

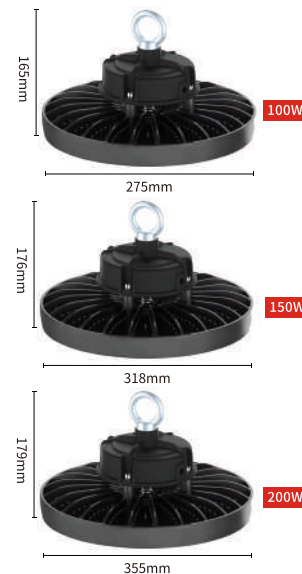

### Safety Certification

Zhaga High Bay Light **LED**

**Product Features**

1. Microwave induction ,intelligent control,smart and power saving;
2. Die-casting aluminum radiator;
3. UFO appearance design,heat dissipation by Air convection;
4. PC annular lens,uniform luminous;
5. Dimming, Bluetooth connection,induction range setting, you can use your phone to operate;
6. Intelligent human body sensing;
7. IP65 ,waterproof and dust-proof,in all kinds of harsh environment it can also maintain normal work.



**Beam Angle**



**Parameters**

Brand	<b>SAHUNG</b>
Model	Zhaga
Material	Die-cast Al
Voltage	AC100-265V
Condition Temp	-20~50°
Warranty	3years~5years
Power	30W~300W
Driver	<b>SAHUNG (Optional)</b>
Anti-Surge	4KV~6KV
Power Factor	0.95PF
IP rating	IP65
Eciency	93%
Chip	<b>CREE (Optional)</b>
Lumens	150 lm/W
CRI	80Ra
CCT	2700K~6500K

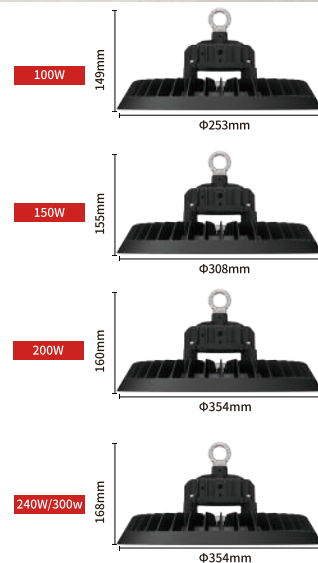

**Safety Certication**



# LED DE VILLE High Bay Light



## Product Features

1. Aluminum reective cover, astigmatism Angle 120°, concentrated Angle 90°;
2. Fin radiator, fast heat dissipation
3. OSRAM led chip with high light eciency;
4. PF reaches 0.95, safe and reliable;
5. Optical PC lens, light transmittance is up to 96%, true reduction of light color;
6. IP65 ,waterproof and dust-proof, in all kinds of harsh environment it can also maintain normal work.

## Beam Angle

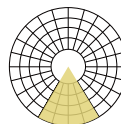

60°

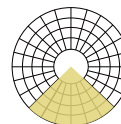

90°



120°

## Parameters

Brand	<b>SAHUNG</b>
Model	DEVILLE
Material	Die-cast Al+PC lens
Voltage	AC85-265V
Condition Temp	-20~50°
Warranty	3~5years
Power	100W~240W
Driver	<b>SAHUNG</b> (Optional)
Anti-Surge	4KV~6KV
Power Factor	0.97PF
IP rating	IP65
Eciency	90%
Chip	OSRAM(Optional)
Lumens	150lm/W
CRI	80Ra
CCT	2700K~6500K



## Safety Certification

CE FC TUV LVD SAA EMC

NOVEL High Bay Light **LED**

**Product Features**

1. The shell is made of aluminum , resistant to corrosion
- 2.OSRAM led chip with high light eciency;
- 3.PF reaches 0.97, anti-surge 6KV, safe and reliable;
- 4.Built-in pure copper 3D stereo heat pipe heat dissipation technology;
- 5.Opal and transparent double PC lens can be selected according to requirements;
- 6.Scaly reective lampshade, luminous uniform, large irradiation area;
- 7.IP65 protection,waterproof and dust-proof,in all kinds of harsh environment it can also maintain normal work.

**Beam Angle**

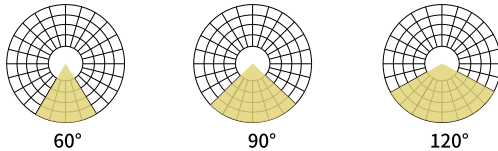

**Parameters**

Brand	<b>SAHUNG</b>
Model	NOVEL
Material	Die-Cast Al+PC Lens
Voltage	AC85-265V
Condition temp	-20~50°
Warranty	3-5 years
Power	100W~200W

Driver	<b>SAHUNG</b> (Optional)
Anti-Surge	4KV~6KV
Power Factor	0.97PF
IP rating	IP65
Eciency	90%

Chip	OSRAM (Optional)
Lumens	150lm/w
CRI	80Ra
CCT	2700K~6500K



**Safety Certication**



LED

GKL High Bay Light



Product Features

1. The lamp is made from ADC12 die-cast aluminum, corrosion resistance;
2. OSRAM led chip with high light efficiency, low light decay;
3. Anti-dazzling PC lens, uniform luminance
4. UFO design, fast heat dissipation
5. MOSO driver power supply, stable performance;
6. Waterproof stainless steel metal ring
7. Double layer convection heat dissipation design
8. IP65 protection, waterproof and dust-proof, harsh environment it can also maintain normal work.

Beam Angle

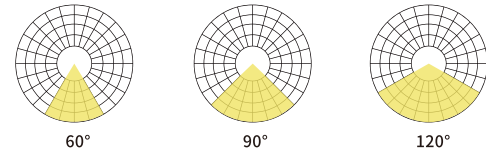

Parameters



Brand	<b>SAHUNG</b>
Model	GKL
Material	ADC12 Die-Cast Al+PC Lens
Voltage	AC90-305V
Condition temp	-20~50°
Warranty	3~5 years
Power	100W~240W

Driver	<b>SAHUNG (Optional)</b>
Anti-Surge	4KV~6KV
Power Factor	0.97PF
IP rating	IP65
Efficiency	93%

Chip	OSRAM (Optional)
Lumens	150lm/w
CRI	80Ra
CCT	2700K~6500K



Safety Certification

CE FC TUV LVD SAA EMC

TXD High Bay Light

LED

Product Features

1. Aluminum shell, corrosion resistance, no rust;
2. OSRAM led chip with high light efficiency;
3. PF reaches 0.95, high power efficiency, safe and reliable;
4. Strip shape design, silver and white painting;
5. Optical PC lens, light transmittance is up to 96%, true reduction of light color;
6. Internal and external heat dissipation, external strip hole heat dissipation;
7. Sahung driver power supply, stable performance;
8. Ceiling installation and chain hoist installation are optional;
9. IP65 protection, waterproof and dust-proof, in harsh environment it can also maintain normal work.

Beam Angle

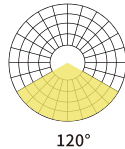
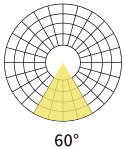

Parameters



Brand	SAHUNG
Model	TXD
Material	Aluminium
Voltage	AC85-265V
Condition temp	-20~50°
Warranty	3-5 years
Power	50W-250W

Driver	SAHUNG (Optional)
Anti-Surge	4KV~6KV
Power Factor	0.97PF
IP rating	IP65
Efficiency	90%

Chip	OSRAM (Optional)
Lumens	150lm/w
CRI	80Ra
CCT	2700K~6500K

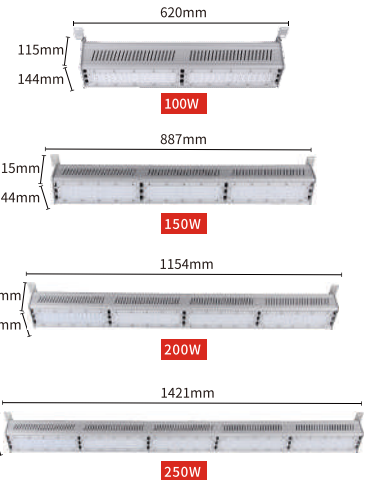

Safety Certification



**LED** Tianhe High Bay Light



**Product Features**

1. The shell is made of aluminum, resistant to corrosion;
2. Fin radiator, fast heat dissipation;
3. OSRAM led chip with high light efficiency;
4. Uniform luminescence, stable transmittance;
5. Optical PC lens, light transmittance is up to 96%, true reduction of light color;
6. Sahung driver power supply, stable performance;
7. IP54, Waterproof and dustproof.

**Beam Angle**

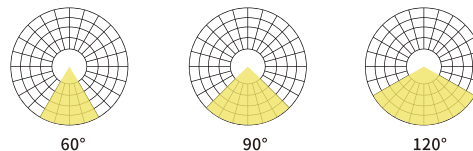

**Parameters**

Brand	<b>SAHUNG</b>
Model	Tianhe
Material	Cold Forging Al
Voltage	AC85-265V
Condition temp	-20~50°
Warranty	3~5 years
Power	100W~200W

Driver	<b>SAHUNG(Optional)</b>
Anti-Surge	4KV~6KV
Power Factor	0.95PF
IP rating	IP54
Efficiency	90%

Chip	OSRAM (Optional)
Lumens	150lm/w
CRI	80Ra
CCT	2700K~6500K



**Safety Certification**



GKA-S High Bay Light **LED**

**Product features**

1. The shell is made of aluminum, resistant to corrosion;
2. OSRAM led chip with high light efficiency;
3. PF reaches 0.97, anti-surge 6KV, safe and reliable;
4. Built-in pure copper heat pipe heat dissipation technology, 3D stereo heat dissipation technology;
5. The whole lamp is tightly installed and sealed, effectively preventing the invasion of dust and matter;
6. Scalable lampshade, luminous uniform;
7. IP65 waterproof and dust-proof, in environment it can also maintain normal work.

**Beam Angle**

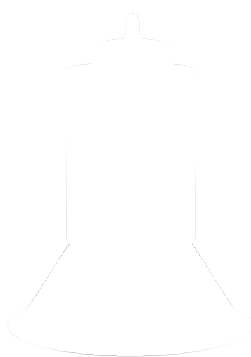
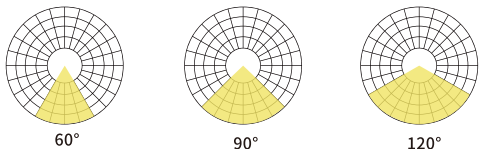

**Parameters**

<b>Brand</b>	<b>SAHUNG</b>
<b>Model</b>	GKA-S
<b>Material</b>	Aluminium
<b>Voltage</b>	AC85-265V
<b>Condition temp</b>	-20~50°
<b>Warranty</b>	3~5 years
<b>Power</b>	50W~200W
<b>Driver</b>	<b>SAHUNG (Optional)</b>
<b>Anti-Surge</b>	4KV~6KV
<b>Power Factor</b>	0.95PF
<b>IP rating</b>	IP54
<b>Efficiency</b>	90%
<b>Chip</b>	<b>OSRAM (Optional)</b>
<b>Lumens</b>	150lm/w
<b>CRI</b>	80Ra
<b>CCT</b>	2700K~6500K

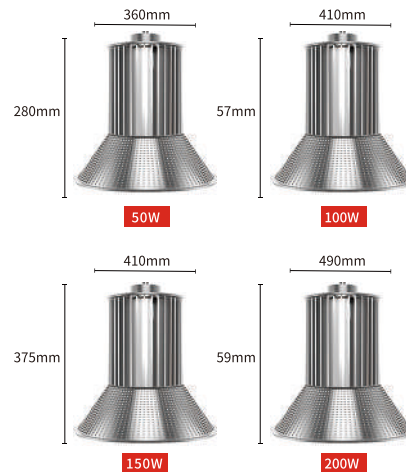

**Safety Certification**



# LED YZD Gas Station Light



## Product Features

1. The lamp is made from aluminum material, corrosion resistance;
2. Module radiator, fast heat dissipation;
3. OSRAM led chip with high light efficiency;
4. PF reaches 0.95, high power efficiency, safe and reliable;
5. PC lens, true reduction of light color;
6. Low Light decay, high lumen;
7. Use stainless steel hexagonal screw;
8. Sahung driver power supply, stable performance;
9. IP65 protection, waterproof in all kinds of harsh environment it can also maintain normal work.

## Beam Angle

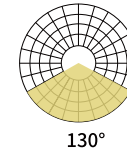
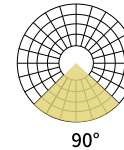

## Parameters

Brand	<b>SAHUNG</b>
Model	YZD
Material	Aluminum+PC lens
Voltage	AC85-265V
Condition temp	-25~65°
Warranty	3~5 years
Power	100W~250W

Driver	<b>SAHUNG (Optional)</b>
Anti-Surge	4KV~6KV
Power Factor	0.95PF
IP rating	IP65
Efficiency	90%

Chip	OSRAM (Optional)
Lumens	150lm/w
CRI	80Ra
CCT	2700K-6500K

## Safety Certification

CE FC TUV LVD SAA EMC CCC

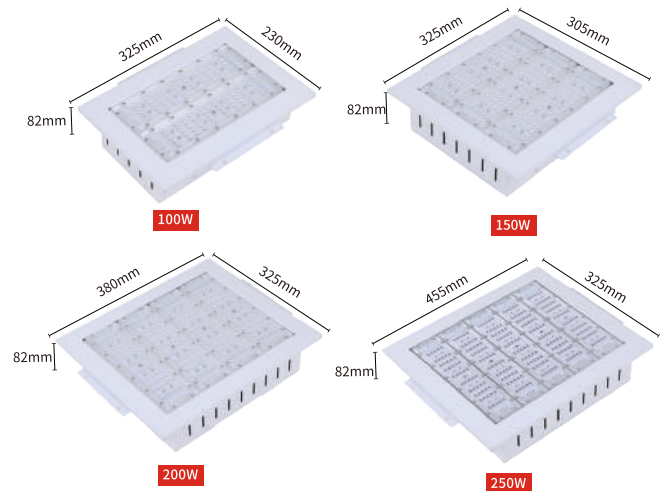

**LED** FeifanTunnel Light



**Product Features**

1. Diuse reection tunnel light,reduce light pollution;
2. Aviation aluminum, ecient heat dissipation;
3. The lamp holder can be adjusted for dierent lighting angles;
4. High transparent lampshade, uniform and soft light ect, no dazling;
5. Sahung driver power supply, waterproof and moisture-proof, stable performance;
6. IP65 ,waterproof and dust-proof,in all kinds of harsh environment it can also maintain normal work.

**Beam Angle**



110°

**Parameters**

Brand	<b>SAHUNG</b>
Model	Feifan
Material	Al+PA6+Tempered Glass
Voltage	AC85-265V
Condition Temp	-20~50°
Warranty	3~5 years
Power	50W~250W
Driver	<b>SAHUNG(Optional)</b>
Anti-Surge	4KV~6KV
Power Factor	0.97PF
IP rating	IP65
Eciency	93%
Chip	LUMILEDS(Optional)
Lumens	140lm/W
CRI	80Ra
CCT	2700K~6500K



**Safety Certication**

CE FC TUV LVD SAA EMC

SDA Tunnel Light

LED

Product Features

1. Aluminum shell, corrosion resistance, no rust;
2. Fin heat dissipation technology;
3. OSRAM led chip with high light efficiency;
4. PF reaches 0.95, high power efficiency, safe and reliable;
5. Optical PC lens, light transmittance is up to 96%;
6. Module design, uniform light, true reduction of light color;
7. 180° Angle free adjustment, safe and convenient;
8. SAHUNG driver power supply, stable performance;
9. IP65, waterproof and dust-proof, in all kinds of harsh environment it can also maintain normal work.



Beam Angle

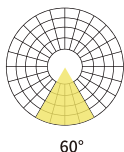

Parameters



Brand	<b>SAHUNG</b>
Model	SDA
Material	Fin radiator /PC lens
Voltage	AC85-265V
Condition Temp	-25~65°
Warranty	3~5 years
Power	50W~200W
Driver	<b>SAHUNG(Optional)</b>
Anti-Surge	4KV~6KV
Power Factor	0.95PF
IP rating	IP65
Efficiency	93%
Chip	OSRAM(Optional)
Lumens	140lm/W
CRI	80Ra
CCT	2700K~6500K

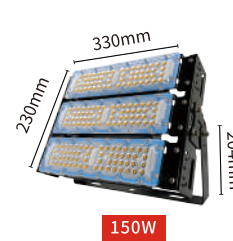

Safety Certification

CE FC TUV LVD SAA EMC

TXR Tunnel Light

LED

Product Features

1. Aluminum shell, corrosion resistance;
2. Integrated design, fast heat dissipation
3. LUMILEDS led chip with high light efficiency;
4. Sahung driver power supply, input voltage AC85V-265V;
5. Optical PC cover, high light transmittance;
6. Waterproof connector, silicone ring seal;
7. IP65, waterproof and dust-proof, in all kinds of harsh environment it can also maintain normal work.

Beam Angle

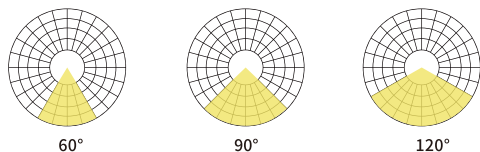

Parameters



Brand	SAHUNG
Model	TXR
Material	Aluminium
Voltage	AC85-265V
Condition temp	-20~50°
Warranty	3~5 years
Power	50W~200W

Driver	SAHUNG (Optional)
Anti-Surge	4KV~6KV
Power Factor	0.97PF
IP rating	IP65
Efficiency	90%

Chip	LUMILEDS (Optional)
Lumens	140lm/w
CRI	80Ra
CCT	2700K~6500K

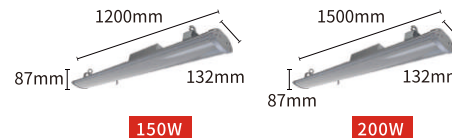

Safety Certification

CE FC TUV LVD SAA EMC

SDK Tunnel Light

LED

Product Features

1. Modular design, aluminum integrated;
2. OSRAM led chip with high light efficiency;
3. 180° rotating bracket, exible Angle adjustment ;
4. Aluminum waterproof IP67 driver, input voltage AC85-265V;
5. SUS304 stainless steel screws and nuts;
6. Bat-wing PC lens improves irradiation range;
7. IP65, waterproof and dust-proof, in harsh environment it can also maintain normal work.

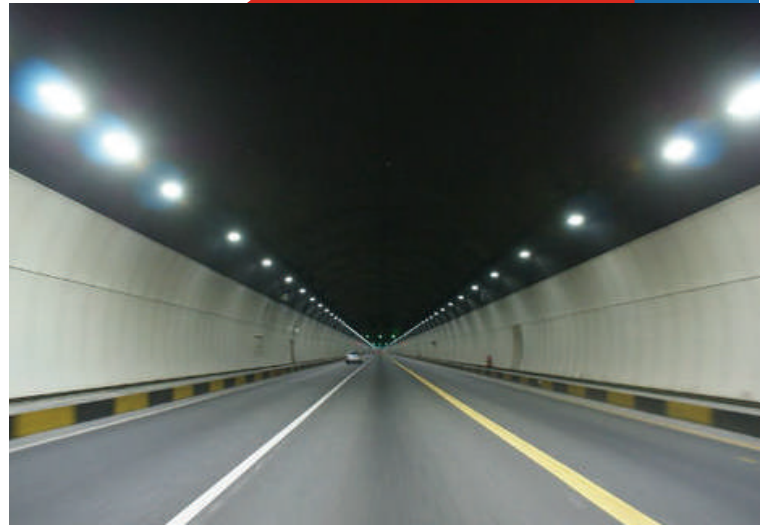

Beam Angle

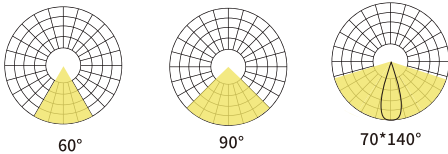

Parameters

Brand	SAHUNG
Model	SDK
Material	Die-cast Aluminium
Voltage	AC85-265V
Condition temp	-20~50°
Warranty	3-5 years
Power	50W~250W
Driver	SAHUNG (Optional)
Anti-Surge	4KV~6KV
Power Factor	0.95PF
IP rating	IP65
Efficiency	93%
Chip	OSRAM (Optional)
Lumens	140lm/w
CRI	80Ra
CCT	2700K~6500K



Safety Certification

CE FC TUV LVD SAA EMC

LED

TG Flood Light



Product Features

1. ADC12 die - cast aluminum shell, fast heat dissipation, stable performance ;
2. OSRAM led chip with high light efficiency;
3. Optical PC lens, high light transmittance , true reduction of light color;
4. Sahung driver power supply, stable performance;
5. Aluminum bracket, 180° adjustable, easy to install;
6. IP65 , waterproof and dust-proof, in all kinds of harsh environment it can also maintain normal work.

Beam Angle

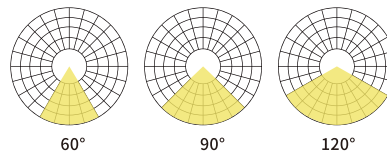

Parameters

Brand	<b>SAHUNG</b>
Model	TG
Material	ADC12 Die-cast Al+PC lens
Voltage	AC85-265V
Condition Temp	-20~50°
Warranty	3~5 years
Power	50W~400W
Driver	<b>SAHUNG (Optional)</b>
Anti-Surge	4KV~6KV
Power Factor	0.97PF
IP rating	IP65
Efficiency	93%
Chip	OSRAM (Optional)
Lumens	140lm/W
CRI	80Ra
CCT	2700K~6500K

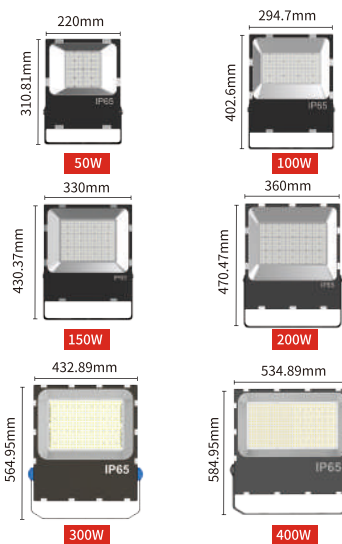

Safety Certification  
 CE FCC TUV LVD SAA EMC

LED

TB Flood Light



Product Features

1. The shell is made of aluminum, corrosion resistance;
2. White integrated die - cast aluminum;
3. OSRAM led chip with high light efficiency;
4. Fast heat dissipation;
5. Optical PC lens, high light transmittance, true reduction of light color;
6. Aluminum bracket, 180° free adjustment;
7. 50mm lamp body, easy to install;
8. IP65, waterproof and dust-proof, in all kinds of harsh environment it can also maintain normal work.

Beam Angle

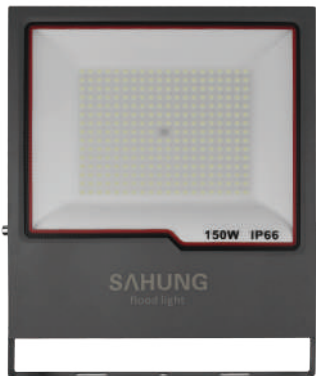

Parameters

Brand	SAHUNG
Model	TB
Material	Stalinite / Die-cast Al
Voltage	AC85-265V
Condition temp	-20~50°
Warranty	3~5 years
Power	50W~200W

Driver	SAHUNG (Optional)
Anti-Surge	4KV~6KV
Power Factor	0.97PF
IP rating	IP65
Efficiency	90%

Chip	OSRAM (Optional)
Lumens	140lm/w
CRI	80Ra
CCT	2700K~6500K



Safety Certification

CE FC TUV LVD SAA EMC

TGS Flood Light

LED



Product Features

1. The shell is made of aluminum, corrosion resistance;
2. White integrated die - cast aluminum;
3. OSRAM led chip with high light efficiency;
4. Fast heat dissipation;
5. Optical PC lens, high light transmittance, true reduction of light color;
6. Aluminum bracket, 180° free adjustment;
7. 50mm lamp body, light and easy to install;
8. IP65, waterproof and dust-proof, in all kinds of harsh environment it can also maintain normal work.

Beam Angle

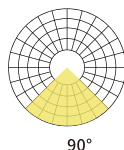
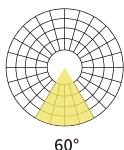

Parameters



Brand	<b>SAHUNG</b>
Model	TGS
Material	Aluminium
Voltage	AC85-265V
Condition temp	-20~50°
Warranty	3~5 years
Power	50W~300W

Driver	<b>SAHUNG (Optional)</b>
Anti-Surge	4KV~6KV
Power Factor	0.95PF
IP rating	IP65
Efficiency	93%

Chip	OSRAM (Optional)
Lumens	140lm/w
CRI	80Ra
CCT	2700K~6500K



Safety Certification

CE FC TUV LVD SAA EMC

TX96 Flood Light

LED

Product Features

1. Die-cast aluminum radiator;
2. LUMILEDS led chip with high light efficiency;
3. Use tempered glass;
4. The 180° adjustable bracket;
5. PC lens, high light transmittance;
6. Streamlined back design, fast heat dissipation;
7. Sahung driver power supply, stable performance;
8. IP65, waterproof and dust-proof, in harsh environment it can also maintain normal work.

Beam Angle

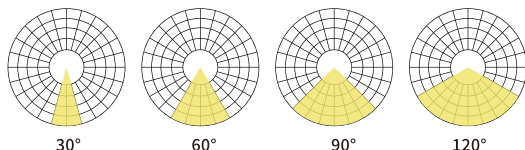

Parameters

Brand	SAHUNG
Model	TX96
Material	Die-cast AL+PC lens
Voltage	AC85-265V
Condition temp	-25~65°
Warranty	3~5 years
Power	50W~250W

Driver	SAHUNG (Optional)
Anti-Surge	4KV~6KV
Power Factor	0.95PF
IP rating	IP65
Efficiency	93%

Chip	LUMILEDS (Optional)
Lumens	140lm/w
CRI	80Ra
CCT	2700K~6500K



Safety Certification

CE FC TUV LVD SAA EMC

LED

SLK Street Light



### Product Features

1. Die-cast aluminum material, corrosion resistance;
2. Air convection heat dissipation, prolong the service life;
3. German OSRAM LED chip with high light efficiency;
4. PF reaches 0.95, safe and reliable;
5. Bat-wing PC lens improves irradiation range;
6. Sahung waterproof driver power supply, input voltage AC85-265V, suitable for global power grid demand;
7. Surge resistance is up to the standard index;
8. IP65 protection, in all kinds of harsh environment it can also maintain normal work.

### Beam Angle

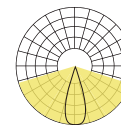

70°\*140°

### Parameters



Brand	<b>SAHUNG</b>
Model	SLK
Material	Die-cast Al
Voltage	AC85-265V
Condition temp	-20~50°
Warranty	3~5 years
Power	50W~240W

Driver	<b>SAHUNG(Optional)</b>
Anti-Surge	4KV~6KV
Power Factor	0.95PF
IP rating	IP65
Efficiency	90%

Chip	<b>OSRAM(Optional)</b>
Lumens	140lm/w
CRI	80Ra
CCT	2700K~6500K



### Safety Certification

CE FC TUV LVD SAA EMC

## Product Features

1. ADC12 die - cast aluminum shell;
2. OSRAM LED chip with high light efficiency;
3. Three types of modules: road light type, street type switch interface can be selected;
4. Sahung driver power supply, stable performance;
5. Stalinite and PC lens;
6. IP65, waterproof and dust-proof, in harsh environment it can also maintain normal work.

## Beam Angle

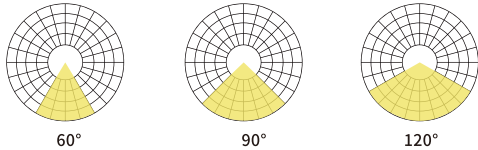

SKT Street Light

LED

## Parameters



Brand	<b>SAHUNG</b>
Model	SKT
Material	ADC12 Die-cast AL
Voltage	AC85-265V
Condition temp	-20~50°
Warranty	3~5 years
Power	100W~300W

Driver	<b>SAHUNG (Optional)</b>
Anti-Surge	4KV~6KV
Power Factor	0.97PF
IP rating	IP65
Efficiency	93%

Chip	<b>OSRAM (Optional)</b>
Lumens	140lm/w
CRI	80Ra
CCT	2700K~6500K



## Safety Certification

CE FC TUV LVD SAA EMC

SLD Street Light

LED



Product Features

1. Die-cast aluminum material, corrosion resistance;
2. OSRAM led chip with high light efficiency;
3. 60mm light pole back cover;
4. Air convection heat dissipation
5. Optical PC lens, high light transmittance;
6. IP65, waterproof and dust-proof, in harsh environment it can also maintain normal work.

Beam Angle

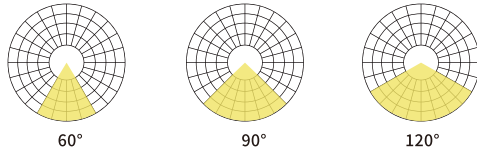

Parameters

Brand	SAHUNG
Model	SLD
Material	Die-cast AL
Voltage	AC85-265V
Condition temp	-20~50°
Warranty	3~5 years
Power	30W~150W

Driver	SAHUNG (Optional)
Anti-Surge	4KV~6KV
Power Factor	0.97PF
IP rating	IP65
Efficiency	90%

Chip	OSRAM (Optional)
Lumens	140lm/w
CRI	80Ra
CCT	2700K~6500K



Safety Certification

CE FC TUV LVD SAA EMC

## Product features

1. Aluminum shell, corrosion resistance, no discoloration;
2. LUMILEDS/OSRAM chip with high light efficiency;
3. Power factor reaches 0.95, safe and reliable;
4. 180° free adjustment, firm and reliable, safe to use;
5. SAHUNG/MOSO driver power supply, stable performance;
6. Use toughened glass, water and dust proof;
7. Fin radiator heat dissipation design, fast heat dissipation;
8. IP66 protection level, waterproof and dust-proof, in all kinds of harsh environment it can also maintain normal work.
9. WF1 Anti-corrosion top grade

## Beam Angle

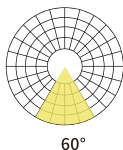
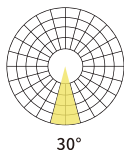

## XF Stadium Light

LED



## Parameters

Brand	SAHUNG
Model	XF
Material	Die-cast Al
Voltage	AC85-265V
Condition temp	-20~50°
Warranty	3~5 years
Power	300W~1200W
Driver	SAHUNG/MOSO(Optional)
Anti-Surge	4KV~6KV
Power Factor	0.95PF
IP rating	IP66
Efficiency	95%
Chip	LUMILEDS(Optional)
Lumens	140lm/w
CRI	80Ra
CCT	2700K~6500K

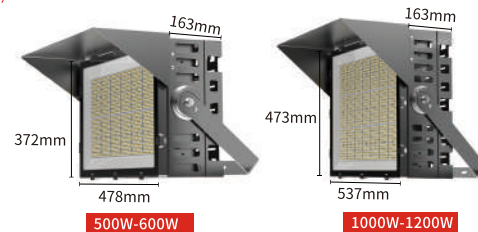

## Safety Certification

CE FC TUV LVD SAA EMC

HTM Stadium Light

LED



Product features

1. Die-cast aviation aluminum material, corrosion resistance;
2. OSRAM led chip with high light efficiency;
3. PF reaches 0.95, high power efficiency, safe and reliable;
4. Optical PC lens, light transmittance is up to 96%, true reduction of light color;
5. Sahung driver, stable performance;
6. IP66, waterproof and dust-proof, in harsh environment it can also maintain normal work.

Beam Angle

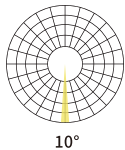

Parameters

Brand	<b>SAHUNG</b>
Model	HTM
Material	Die-cast Al
Voltage	AC90-305V
Condition temp	-20~50°
Warranty	3~5 years
Power	500W~1800W
Driver	INVENTRONICS(Optional)
Anti-Surge	4KV~6KV
Power Factor	0.95PF
IP rating	IP65
Efficiency	90%
Chip	OSRAM(Optional)
Lumens	160lm/w
CRI	80Ra
CCT	2700K~6500K

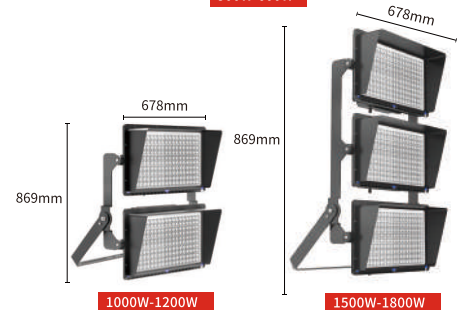

Safety Certification

CE FC TUV LVD SAA EMC

QCB Stadium Light

LED

Product Features

1. Aluminum shell, corrosion resistance;
2. Air convection design, rapid heat dissipation;
3. Hexagonal stainless steel screw;
4. 180° rotating bracket, exible installation;
5. PF reaches 0.95, high power efficiency, safe and reliable;
6. Sahung driver power supply, stable performance;
7. IP65, waterproof and dust-proof, in all kinds of harsh environment it can also maintain normal work.

Beam Angle

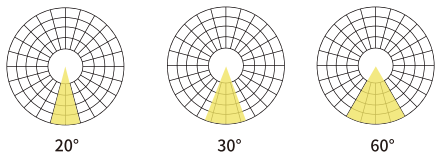

Parameters

Brand	<b>SAHUNG</b>
Model	QCB
Material	Die-cast Al+Lampshade
Voltage	AC85-265V
Condition Temp	-20~50°
Warranty	3~5 years
Power	100W~600W
Driver	<b>SAHUNG</b> (Optional)
Anti-Surge	4KV~6KV
Power Factor	0.95PF
IP rating	IP66
Efficiency	90%
Chip	OSRAM (Optional)
Lumens	140lm/W
CRI	80Ra
CCT	2700K~6500K

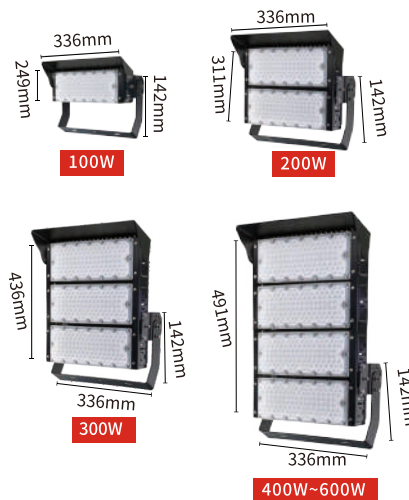

Safety Certification

CE FCC TUV LVD SAA EMC

LED

HCD Stadium Light

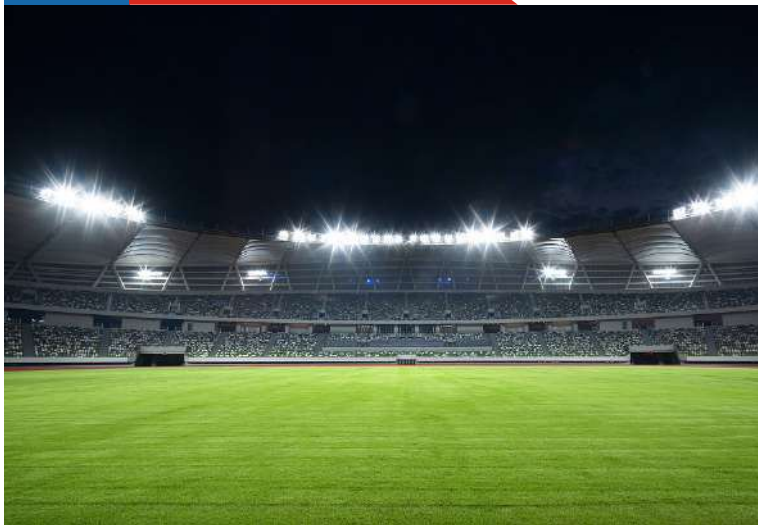

Product Features

1. Aluminum shell, corrosion resistance;
2. OSRAM led chip with high light efficiency;
3. PF reaches 0.95, safe and reliable;
4. 180° free adjustment, firm and reliable
5. Sahung driver power supply, stable performance;
6. Use toughened glass, water and dust proof;
7. Die cast aluminum heat dissipation design
8. IP65, waterproof and dust-proof, in harsh environment it can also maintain normal work.

Beam Angle

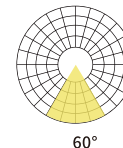
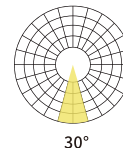
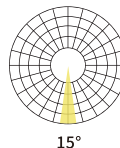

Parameters



Brand  
Model  
Material  
Voltage  
Condition temp  
Warranty  
Power

Driver  
Anti-Surge  
Power Factor  
IP rating  
Efficiency

Chip  
Lumens  
CRI  
CCT

SAHUNG

HCD  
Die-cast Al  
AC85-265V  
-20~50°  
3~5 years  
200W~2000W

SAHUNG(Optional)

4KV~6KV  
0.97PF  
IP65  
93%

OSRAM(Optional)

140lm/w  
80Ra  
2700K~6500K

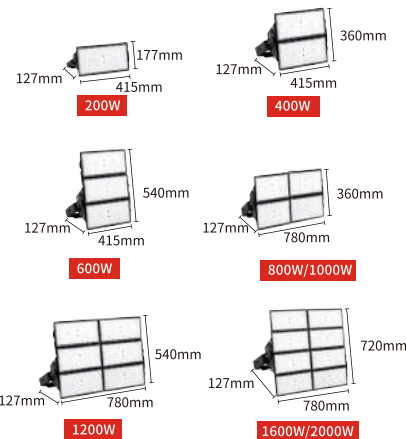

Safety Certification



TGW Stadium Light

LED

Product Features

- 1.AL6063 tensile aluminum radiator, corrosion resistant
- 2.OSRAM led chip with high light eciency;
- 3.PF reaches 0.95, safe and reliable;
- 4.240° bracket adjustment, ADC12 integration die casting;
- 5.Sahung driver power supply, stable performance;
- 6.Optical PC lens, high transmittance;
- 7.The back is streamlined with lower wind resistance;
- 8.IP65,waterproof and dust-proof,in harsh environment it can also maintain normal work.

Beam Angle

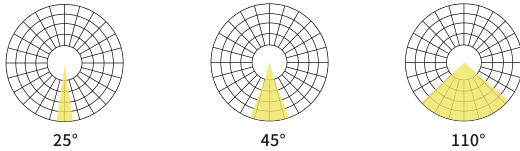

Parameters

Brand	<b>SAHUNG</b>
Model	TGW
Material	AL6063 Drawn Al
Voltage	AC85-265V
Condition temp	-20~50°
Warranty	3~5 years
Power	200W~1000W

Driver	<b>SAHUNG(Optional)</b>
Anti-Surge	4KV~6KV
Power Factor	0.97PF
IP rating	IP65
Eciency	93%

Chip	<b>OSRAM(Optional)</b>
Lumens	140lm/w
CRI	80Ra
CCT	2700K~6500K

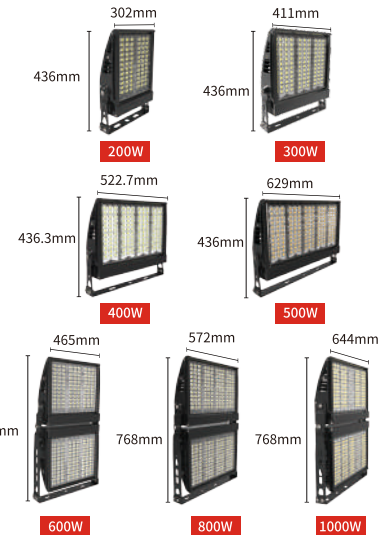

Safety Certification

CE FC TUV LVD SAA EMC

# LED HTD Tower Crane Light



## Product Features

1. The shell is made of aluminum, corrosion resistance;
2. OSRAM led chip with high light efficiency;
3. PF reaches 0.97, high power efficiency, safe and reliable;
4. 3D stereo heat dissipation, HTD technology;
5. Multi-angle adjustment brackets, 13 adjustment brackets;
6. Stalinite lens, true reduction of light color;
7. Sahung driver, stable performance;
8. IP65, waterproof and dust-proof, in harsh environment it can also maintain normal work.

## Beam Angle

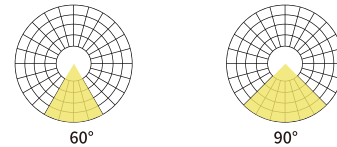

## Parameters

Brand	<b>SAHUNG</b>
Model	HTD
Material	Fin radiator+Stalinite
Voltage	AC85-265V
Condition temp	-20~50°
Warranty	3~5 years
Power	100W~600W
Driver	<b>SAHUNG(Optional)</b>
Anti-Surge	4KV~6KV
Power Factor	0.97PF
IP rating	IP65
Efficiency	90%
Chip	<b>OSRAM(Optional)</b>
Lumens	140lm/w
CRI	80Ra
CCT	2700K~6500K



## Safety Certification

CCC CE FCC TUV LVD SAA EMC



**SUPERIOR BRAND OF  
SHANGHONG INDUSTRIAL LIGHTING**

**ABOUT US**

**PT KRAKATAU SUPPLY ENERGI INDONESIA**

---

PH : +62 821-2222-8303

EMAIL : [sales@kseindonesia.com](mailto:sales@kseindonesia.com)

OFFICIAL WEBSITE : [www.kseindonesia.com](http://www.kseindonesia.com)

ADDRESS : Komplek Perum. Lebak Indah Griya Asri Blok D4/17 - D5/05 RT.006 RW.007

Lebakwana, Kramatwatu, Serang - Banten Indonesia 42161

